

## 箱內零件

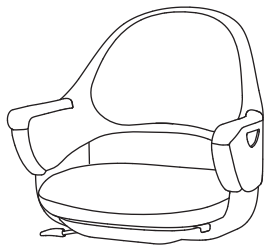

**A**



**B**

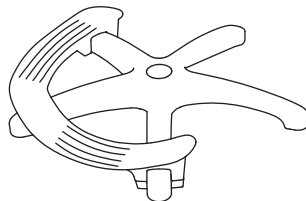

**C**

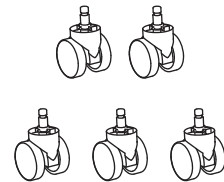

**D**



建議將椅子放置在紙箱或桌面上，更加方便組裝！



組裝前請確認螺絲與配件是否備齊，一經組裝將影響退貨權益。

### STEP 1

結合 C (椅腳) 以及 D (椅輪)。

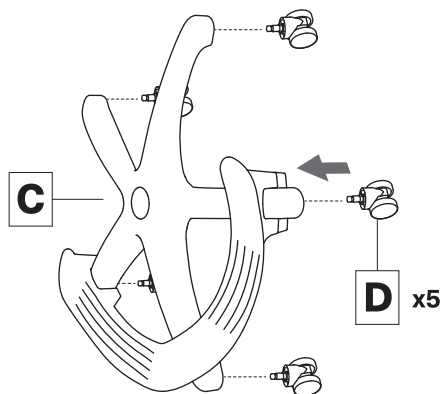

### STEP 2

將組合好的 C+D (椅腳結構) 平放於地板上，將 B (氣壓棒) 之粗端朝下、細端朝上，插入圓孔內。

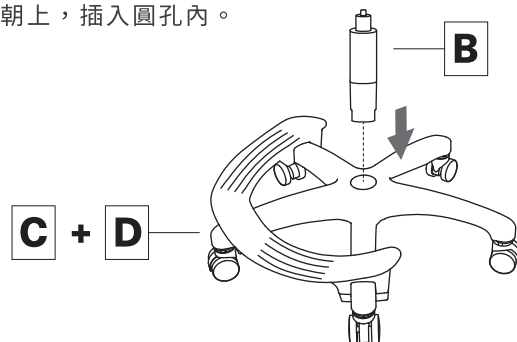

### STEP 3

將 A (椅座) 下方之圓孔與氣壓棒細端對齊後，垂直向下插入氣壓棒安裝圓孔內。

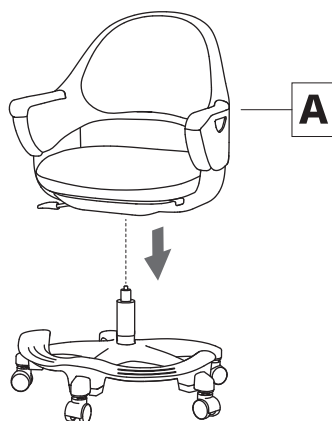

### Backbone® 椎座工學

如有後續組裝問題，請掃描下方客服QR CODE，或是聯絡專業組裝顧問 (02)2356-9828

LINE



FACEBOOK



客服時間  
10:00-18:30

# Kuma™ 使用說明



承重可達 80 KG



座高調整



扶手 & 椅背高度調整



座深前後調整

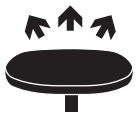

一體成型加厚泡棉



抗菌皮革



環保 PP 材質



坐煞輪

## 扶手 & 椅背高度調整

同時向上拉扶手兩側提把，即可調整椅背 & 扶手高度，共4段調節。

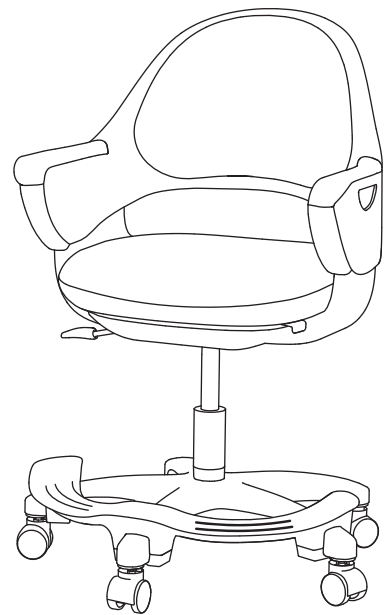
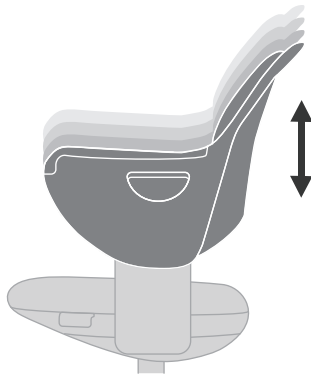

## 座椅高度調整

向上扳起控制桿，調整座椅升降。

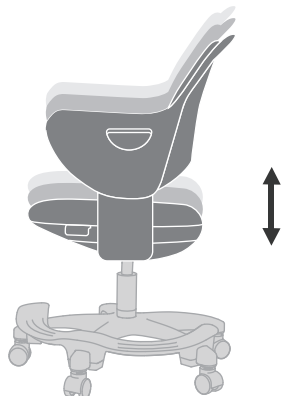
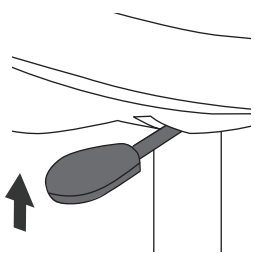

## 座椅深度調整

向外拉住調整鈕，即可前後滑動座墊，調整座深。

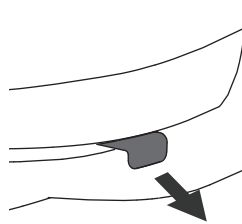

6 CM

